

Since 1898
CONSEW®

CONSOLIDATED SEWING MACHINE CORP.

└ INDUSTRIAL SEWING & CUTTING EQUIPMENT

OPERATING INSTRUCTIONS

and PARTS LIST

for

**CONSEW MODELS 18 and 118
INDUSTRIAL SEWING MACHINES**

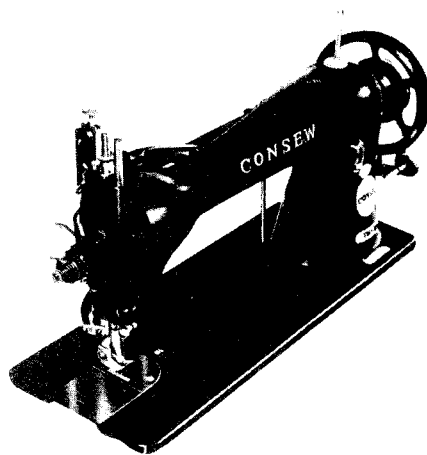

CONSOLIDATED SEWING MACHINE

Oiling must be done at least twice daily when the machine is in continuous operation to assure free-running and durability of the operating parts.

NOTE—During the breaking-in period a new machine should be oiled more frequently.

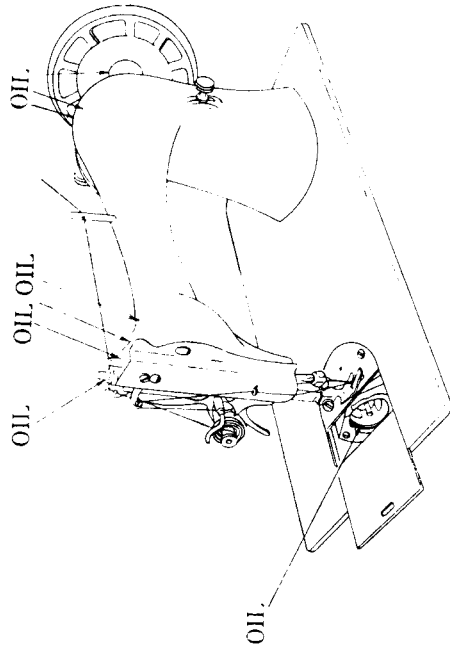

Fig. 1

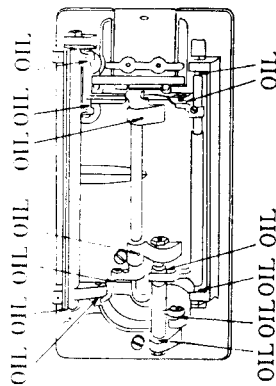

Fig. 2

NEEDLE AND THREAD SELECTION

Consew Model 18 machines use standard styles 16X63 needles for sewing cloth and 16X64 for leather and plastics ranging in sizes from 14 to 25. The thickness of the sewing thread, which must pass freely through the eye of the needle, determines the size of the needle.

SETTING UP THE MACHINE

Carefully unpack machine from packing case and make sure that all small parts and accessories are removed from packing material.

Wipe machine clean of protective grease and lubricate all oil holes with a good grade of sewing machine oil (see below).

The bed of the machine is made to standard dimensions and requires a normal "long arm" table cut-out, size 19" X 7-1/8"

CAPACITY AND SPEED

Consew Model 18 is designed for sewing light and medium-weight materials in cloth, plastics, and leather. It is equipped with independently adjustable upper and lower feeding mechanisms. As a consequence, upper and lower layers of material can be fed slower or faster, as the need arises.

Maximum possible stitch length is 4 stitches per inch.

Maximum operating speed is 1400 stitches per minute, depending of course on the type of material being sewn and its thickness.

To assure durability and trouble-free operation, it is imperative that for the first several weeks of operation the maximum speed is held to no more than 1000 to 1200 stitches in order to allow the parts to become properly broken in.

DIRECTION OF ROTATION AND OPERATING SUGGESTIONS

In operation, the handwheel of the machine always turns toward the operator. To avoid tangled threads and jamming of the sewing hook, do not turn hand-wheel otherwise.

Always be sure that there is material between the presser feet and the feed dog when running the machine, particularly when the machine is fully threaded.

The machine will feed the material without your assistance. Therefore, do not pull the fabric as this may cause damage to the needle.

OILING

Do not operate the machine, even if only for testing, unless it has been properly oiled at every spot requiring lubrication. The arrows on the following illustration indicate these spots.

Remember—uneven, knotted or rough thread impairs the satisfactory sewing performance of your machine.

Only **left** twist thread is to be used for the needle. To test for twist hold a length of thread between thumbs and index fingers of your hands. Turn thread counterclockwise. If it will twist tighter, it has a left twist. If it unravels, it has a right twist.

The bobbin can be wound with either left or right twist thread.

THREADING THE NEEDLE

From the thread stand lead the thread through hole A in the spool pin on top of the arm and over guide B at rear of the upper end of the face plate. Now run it downward and around between the two tension discs C from the back, then over the wire guide D, and down again through the loop of the check spring E, straight upward through the eye of the take-up lever F from the rear, down again through thread guides G and H and from left to right through the eye of the needle. Pull about two to three inches of thread through the needle's eye before you begin with sewing.

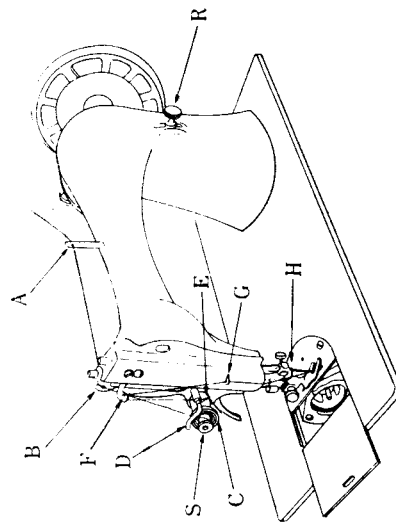

Fig. 3

REMOVING AND INSERTING THE BOBBIN CASE

Pull out slide plate, lift latch of bobbin case with thumb and forefinger and take bobbin case out of machine. Bobbin will drop out when the open end of the bobbin case is held downward and the latch is released.

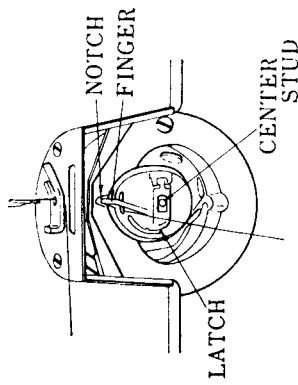

Fig. 4

Take bobbin case by the latch after the full bobbin has been inserted and place it on the center stud of the shuttle. See that the finger of the bobbin case is in line with the notch on top of the shuttle race.

Release the latch and press the bobbin case into the shuttle until the latch catches on the center stud of the shuttle. The bobbin thread should hang down freely about four inches.

INSERTING A NEW NEEDLE

Turn handwheel toward you until needle has reached the highest point of its travel. Loosen the needle set screw about one turn, pull out the old needle and insert a new one. Push the needle up into the needle bar as far as it will go, setting its long groove toward the left with eye of the needle going from left to right. Tighten needle set screw securely.

WINDING BOBBINS

The bobbin winder is mounted on the table top with its pulley in front of the driving belt so that the pulley will separate from the belt after the bobbin has been wound with sufficient thread.

Push the bobbin on bobbin winder spindle as far as it will go. Pass thread from thread stand downward through eye in tension bracket; then between and around the back of the tension discs. Bring thread forward toward bobbin and wind from below in clockwise direction several times around bobbin. Push bobbin winder lever downward until wheel contacts the drive belt and start machine. After bobbin is filled with thread, release will cause wheel to

disengage from belt and winding will stop. Cut thread and remove bobbin from winder spindle.

Adjustment screw can be turned in or out to increase or decrease the amount of thread wound on the bobbin.

When fine thread is wound on bobbins, use light tension. It is regulated by turning the knurled nut on the tension bracket at the rear of the bobbin winder. Bobbin can be wound while the machine is sewing.

THREADING THE BOBBIN CASE

1. Hold bobbin case between thumb and forefinger of left hand, so that the slot in the edge of the bobbin case is on top as shown in Fig. 5.

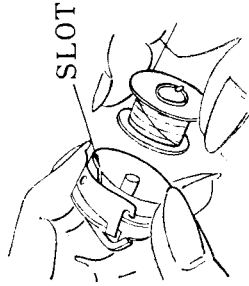

Fig. 5

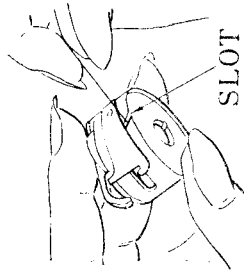

Fig. 6

2. Take the bobbin between thumb and forefinger of right hand so that the thread on top leads from the left to the right, as shown in Fig. 6.

3. Insert bobbin into bobbin case, pull the thread into the slot of the bobbin case as shown in Fig. 6 and then draw it under the tension spring and into the fork-shaped opening of the spring as seen in Fig. 7.



Fig. 7

ADJUSTING THE STITCH LENGTH

The length of stitch is changed by movement of the knurled knob in the slot at front of the machine frame (Fig. 3). Turn this knob counterclockwise to unlock it and move it downward to lengthen the stitch. To obtain a shorter stitch, move it in upward direction. Lock knob turning it clockwise after the correct length of stitch has been selected.

SEWING PROCEDURE

Turn the balance wheel towards you with the right hand until the needle moves down and up again to its highest point, thus catching the lower (bobbin) thread. Now pull the end of the upper thread you are holding and the bobbin thread will be brought up with it through the needle hole in the needle plate.

Place both ends of thread back under the presser foot. Place the material to be sewn beneath the presser foot, lower the foot upon it and then start the machine.

TO REMOVE THE WORK

Raise the needle bar to its highest point; lift the presser foot and draw the fabric back and to the left. Cut the ends of the threads a few inches long from the needle

REGULATING THE THREAD TENSIONS

For ordinary stitching, the tension on the upper and lower threads should be equal so as to lock both threads in the center of the fabric.

If the tension on either thread is stronger than on the other, imperfect stitching will be the result. If the tension on the upper thread is greater than that on the lower there it will lie straight along the upper surface of the fabric. If the tension on the lower thread is greater than that on the upper thread, the lower thread will lie straight along the underside of the fabric

A. Tension of the upper (Needle) thread:

Before adjusting the tension of the upper (needle) thread, be certain that the presser foot is let down and not in lifted position. Turn serrated nut "S"

INDEX

ACCESSORIES	PAGE
BOBBIN WINDER	8
KNEE LIFTER	3/7
PRESSER FOOT AND UPPER FEED DOG	7
PARTS FOR WIDER SEAM	7

The word C stamped at the side of parts No. means a complete set of the parts.

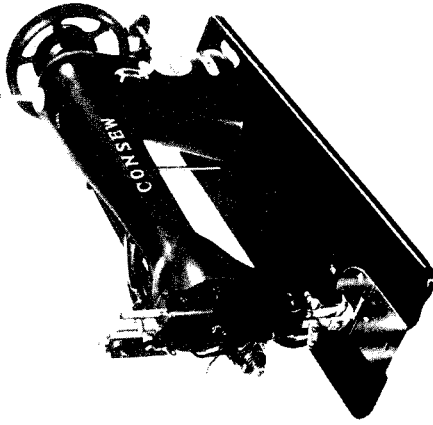

MODEL 18

on tension device to the right to increase tension and to the left, if you desire to decrease it.

B. Tension of the lower (Bobbin) thread :

Once the tension of the lower (bobbin) thread has been adjusted correctly, it is rarely necessary to adjust it ever again. However, if it should ever require regulation, do so by carefully turning the single screw located at the outside of the bobbin case shell on top of the tongue-shaped curved spring. Turn this screw clockwise no more than 1/4 turn at one time to tighten tension and counterclockwise to loosen it.

THE UPPER FEEDING MECHANISM

For normal sewing operation the upper feeding mechanism is adjusted to work in synchronism with the feed dog in the bed of the machine. By loosening set screw "N" (Fig. 8) and turning thumb screw "P" clockwise the top layer of material can be fed faster. Turning the thumb screw "P" counter clockwise will feed it slower than the bottom layer. Be sure to tighten set screw "N" after adjustments are made.

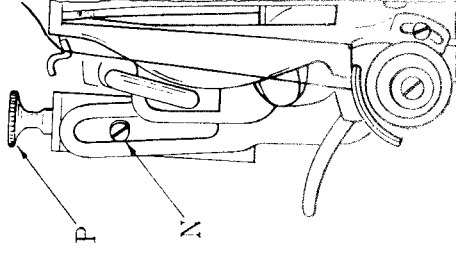

Fig. 8

PARTS NO.	PAGE	NAME	PARTS NO.	PAGE	NAME
6004	101	Oscillating rock shaft crank	6031	106	Needle plate set screw
6005	103	" " " shaft screw pipe	6033	106	Slide plate
6006	104	Lower shaft crank	6034	106	Oscillating hook slide friction spring
6007	104	" " " slide block	6035	106	Slide plate spring screw
6008	105	Lower shaft	6050 C	109	Bobbin winder complete(6051 C & 6052 C)
6009	103	Shuttle driver	6051 C	109	Bobbin winder
6010	106	Shuttle race body	6052 C	109	Bobbin winder spool stand complete
6010	106	shuttle race complete	6053	109	" base
6011	106	Shuttle race back	6054	109	" pulley
6012	106	" " " spring	6055	109	" spindle
6013	106	" " " " screw	6056	109	" frame
6014	106	" " " cap spring	6057	109	" stop latch
6015	106	" " " " screw	6058	109	" frame hinge screw
6016	106	" " " body	6059	109	" " " nut
6017	106	Bobbin case	6060	109	" " " spring
6018	110	Bobbin	6061	109	" stop latch hinge screw
6019	105	Feed rock shaft rocker bar	6062	109	" pulley set screw
6020	103	Feed driven rock shaft crank	6063	109	" spool stand
6021	101	Feed base	6064	109	" " pin
6022	105	Feed lifting rock shaft	6065	109	" tension screw stud
6023	103	" " " crank	6066	109	" " disc
6024	103	" " " " roller	6067	109	Bobbin winder tension spring
6025	103	" " " " set screw	6068	109	" " " " regulating thumb nut
6026	101	Feed base center screw with nut	6069	109	" " " " thread guide
6027	103	Feed rock shaft center screw	6070	109	" " " " screw
6027	103	Feed lifting rock shaft center screw	6071	110	Wrench
6027	103	Center screw with nut(8013) complete	6073	110	Scale
6028	101	Feed dog	6074	110	" " " " set screw
6029	101	" " " " set screw	6075	110	Machine rest pin(wood)
6029	109	Upper feed rod pin set screw	6076	111	Machine hinge plate
6030	106	Needle plate	6077	111	Machine hinge connection

PARTS NO.	PAGE	NAME	PARTS NO.	PAGE	NAME
6321	106	Thread take up cam	6078	111	Machine hinge plate set screw
6322	106	" " crank pipe	6079	111	Knee lifter complete
6323	106	" " " screw	6080	111	Rock shaft for 6079
6324	102	" " " "	6081	111	" " hanger
6325	102	" " " roller stud	6082	111	" " knee arm
6326	102	" " " " pin	6083	111	" " " plate
6327	106	Needle bar crank	6084	111	" " " arm hub
6328	106	" " " connecting stud	6085	111	" " " lifting bracket
6329	103	Needle bar	6086	111	" " " " hook
6330	103	Needle clamp	6087	111	" " " stop dog
6331	103	Needle bar thread guide	6088	111	" " " knee arm set screw
6332	104	Thread take up lever complete	6088	111	" " " plate screw
6332	104	Thread take up lever	6088	111	" " " lifting bracket set screw with hook
6333	104	" " " " set screw	6088	111	" " " stop dog set screw
6334	102	Upright bracket plate	6090	112	Drip pan
6335	102	Upper feed dog set plate	6303		Upper feeding rock shaft front metal
6336	102	" " " " " base	6304		" " " " " set screw
6337	102	" " " " " pin	6305		" " " " " rear metal
6338	102	" " " " " bracket	6306		" " " " " base
6339	102	" " " " " screw	6307	103	Upper feeding rock shaft
6340	102	Presser bar guide bracket	6308	104	Feed cam
6341	102	" " " " " set screw	6309	101	Upper feed forked connection
6342	102	" " " " " roller	6310	102	" " " regulator box
6343	102	Presser bar attaching bracket	6311	102	" " " slide stud
6344	102	" " " " " set screw	6313	108	Balance wheel
6345	102	Presser bar lifter & knee lifter connecting rod connector	6314	102	Upper feed regulator thumb screw
6346	102	" " " " " " pin	6315	102	" " " " " screw (long)
6347	102	Upper feed dog set plate connecting plate	6316	102	" " " " " receiver
6348	102	" " " " " double binding screw	6317	102	" " " " " " set screw
6349	103	Middle presser foot	6318	101	Upper feed rod
			6320	109	" " " set pin

PARTS NO.	PAGE	NAME	PARTS NO.	PAGE	NAME
6350	103	Upper feed dog	8007	104	Feed cam set screw
6351	103	Presser bar lifing lever	8007	104	Balance wheel screw
6352	109	" " set screw	8008	104	Rear bush
6353	107	Face plate	8009	104	" screw
6353	107	Face plate complete	8009	108	Knee lifter lifing lever hook screw
6354	108	Knee lifter lifing lever	8010	101	Crank connecting rod
6355	108	" " hook	8012	101	Oscillating rock shaft crank shaft
6356	109	Lifing lever connecting bar	8013	101	" " nut
6356	109	Lifing lever connecting bar complete	8013	103	Feed rock shaft center screw nut
6357	108	Arm side cover	8013	103	Oscillating rock shaft crank shaft screw pipe nut
6358	103	Presser bar thumb screw nut	8013	103	Feed lifing rock shaft center screw
6359	109	Lifing lever connecting bar joint	8014	101	Forked rod screw
6360	109	" " " nut	8014	101	Connecting rod screw
6361	109	" " " joint set screw	8014	101	Feed regulator connecting rod screw
6363	109	Upper shaft screw	8020	103	Lower shaft crank pin
6365	105	Upper shaft	8020	103	Shuttle driver pin
6366	106	Needle bar crank set screw	8023	106	Thread take up cam pin
6367	104	Knee lifter bell crank body			Upper feeding rock shaft pin
6368	104	" " " pin	8031	107	Tension spring receiver set screw
6369	104	" " " spring	8031	107	Tension thread guide set screw
6370	104	" " " set screw	8031	103	Needle bar thread guide set screw
6371		Upper feed rod base	8035	104	Thread take up lever roller with nut
6372		" " set screw	8036	103	Presser regulating thumb screw
7020	104	Feed regulator body	8037	103	Presser bar spring
7023	107	Tension spring receiver	8039	103	Presser bar
7025	107	Tension thread guide (big)	8040	103	Upper feed dog screw
7026	107	" " (middle)	8042	104	Lower shaft crank set screw
7027	107	" " (small)	8053	101	Forked rod
7028	107	Thread take up spring	8054	104	Feed regulator connecting rod
7029	107	Tension releasing	8056	104	Feed regulator set screw
7030	107	" " pin	8057	104	" thumb screw

PARTS NO.	PAGE	NAME	PARTS NO.	PAGE	NAME
8060	107	Tension thread guide set screw(middle)	6312		Upper feed regulator box (instead of 6310)
8060	107	Face plate set screw	6319		Upper feed rod (instead of 6318)
8076	107	Tension screw stud.	6362		Upper feed regulator thumb screw(instead of 6314)
8077	107	Tension disc wheel	6364		Feed regulator body (instead of 7020)
8078	107	Tension spring			
8079	107	Tension stud nut			
8086	109	Knee lifter lifting lever hinge screw			
8091	106	Shuttle race set screw			
8093	109	Arm side cover set screw			
8102	109	Spool pin			
8104	104	Feed regulator screw washer	6071	110	Wrench
8115	110	Screw driver (big)	6073	110	Scale
8116	110	" (small)	6074	110	" set screw
8119	110	Oil can	8115	110	Screw driver (big)
			8116	110	" (small)
			8119	110	Oil can
					Oil
					Needle 3 pcs.
					Bobbin 3 pcs.

CONTENTS OF ACCESSORIES BOX

PRESSER FOOT AND FEED DOG (Different size)

6349	113	Middle presser foot (standard)
6350	113	Upper feed dog (")
6349	113	Middle presser foot (bottom 1/8" grooved)
6350	113	Upper feed dog (" " ")
6349	113	Middle presser foot (" 3/16" ")
6350	113	Upper feed dog (" " ")
6349	113	Middle presser foot (" 1/4" ")
6350	113	Upper feed dog (" " ")
6349	113	Middle prsrer foot (" 5/16" ")
6350	113	Upper feed dog (" " ")

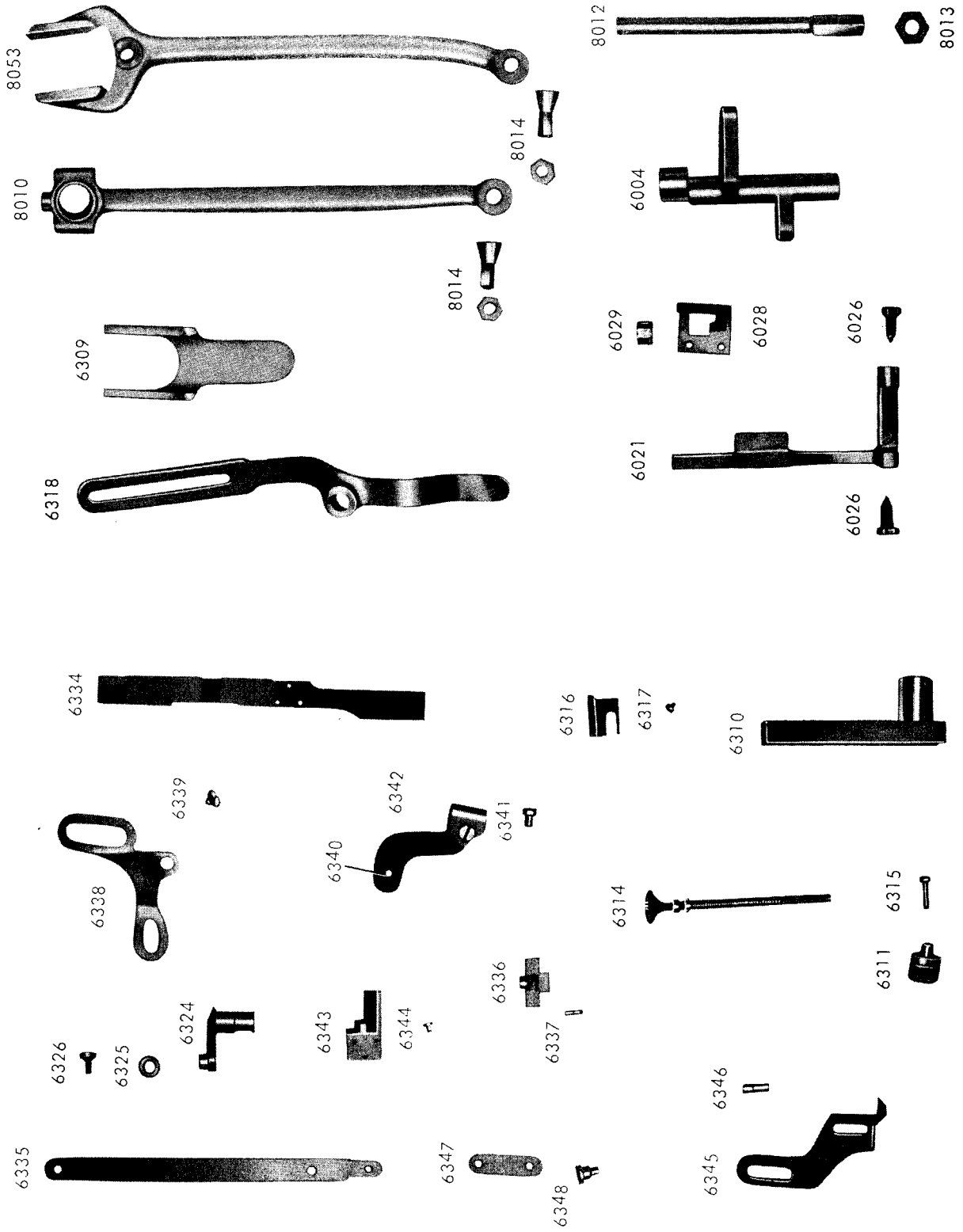

6307



8036



6329



8039



6349



6358



6024



6023



6025



6020



6330



8040



6350



6331



6351



8031



8020



6009



6027



6027

7020



8008



6308



8009



8007



8056



8104



6333



6332

6332

8057



6367



6370



8054



6368



8042



6006



6369



6007



6353 C

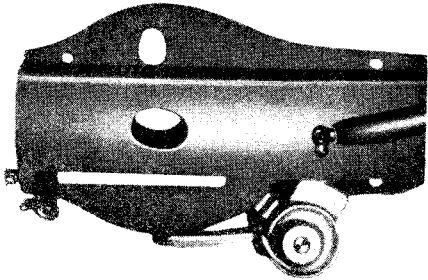

6353

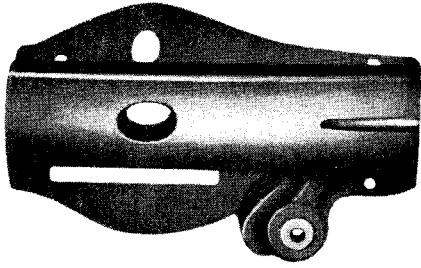

6313

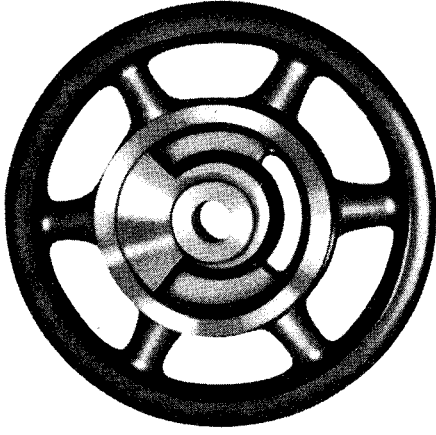

8077



7025



8076



8079



7023



7029



8078



8060



7030



8031



6357

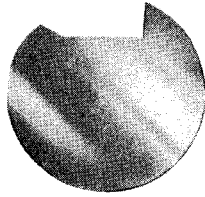

8009



6355



6354



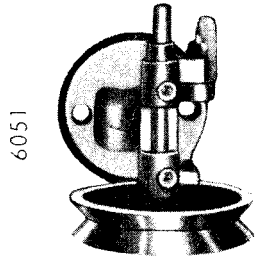
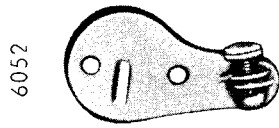
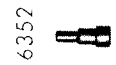
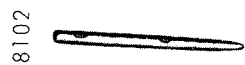
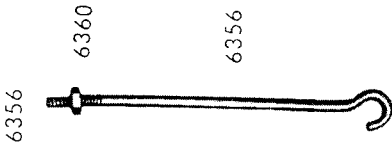
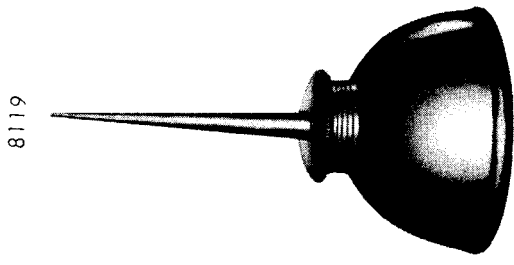
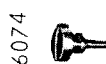
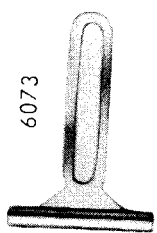
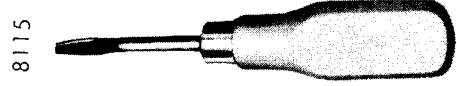
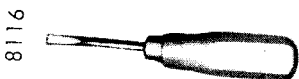

6090

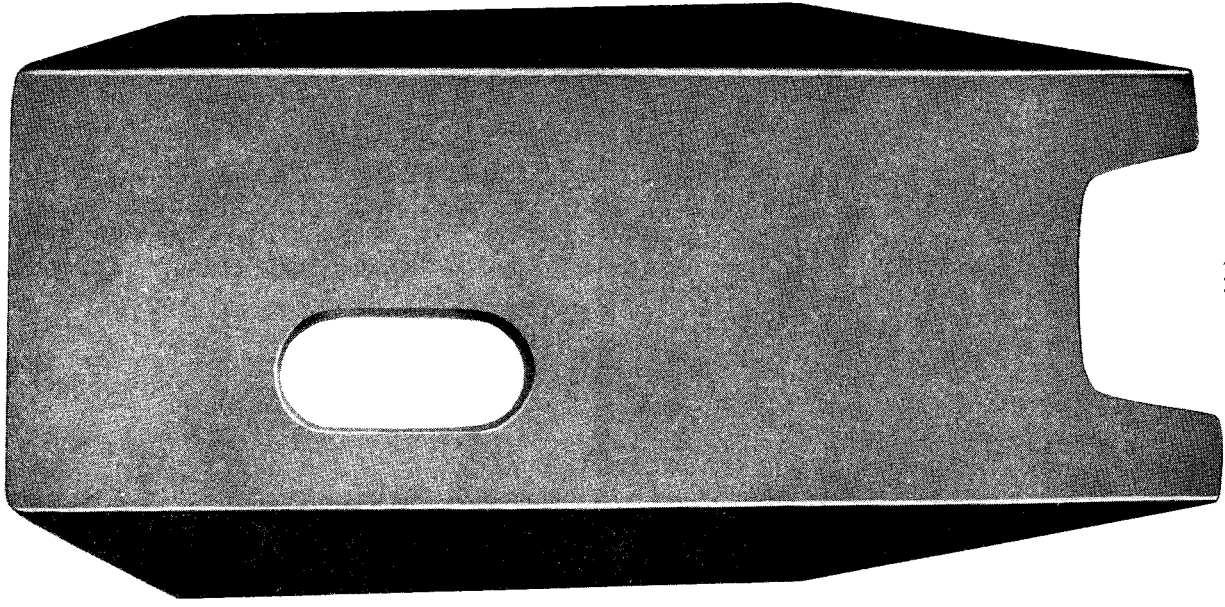

--- 112 ---

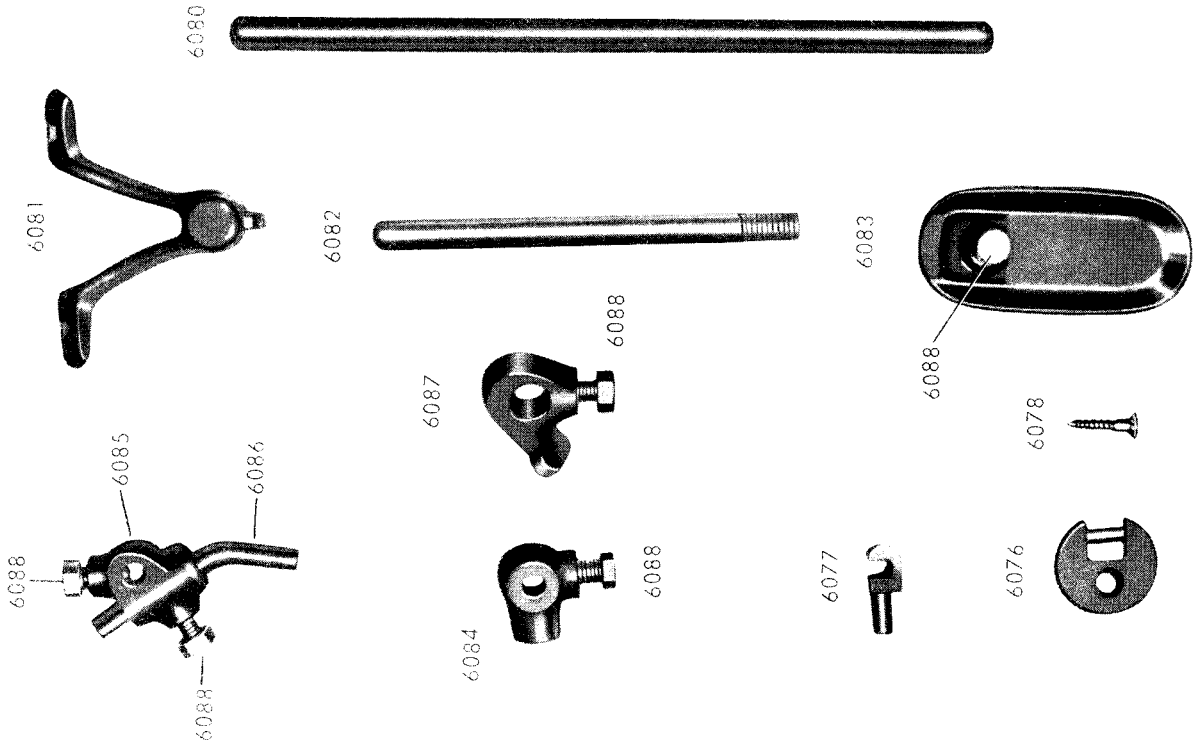

6079

--- 111 ---

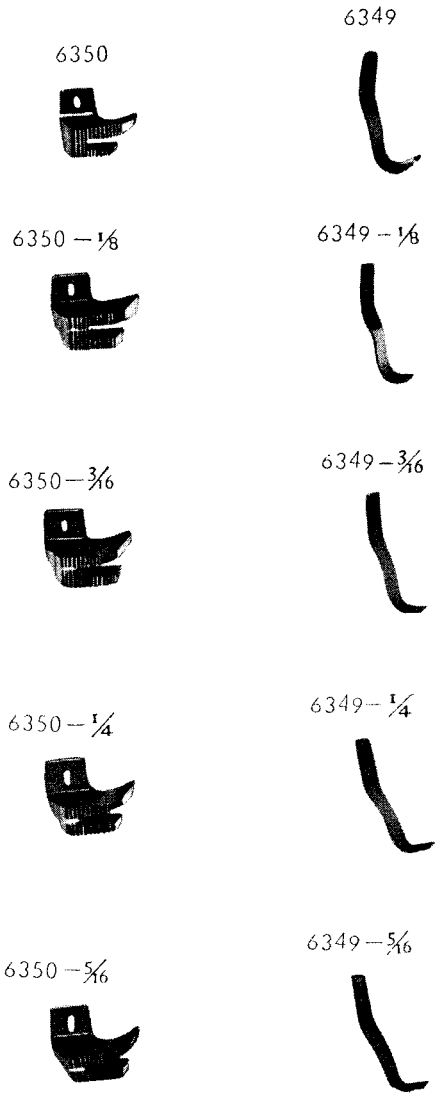

.....
PARTS FOR 118 REVERSE FEED

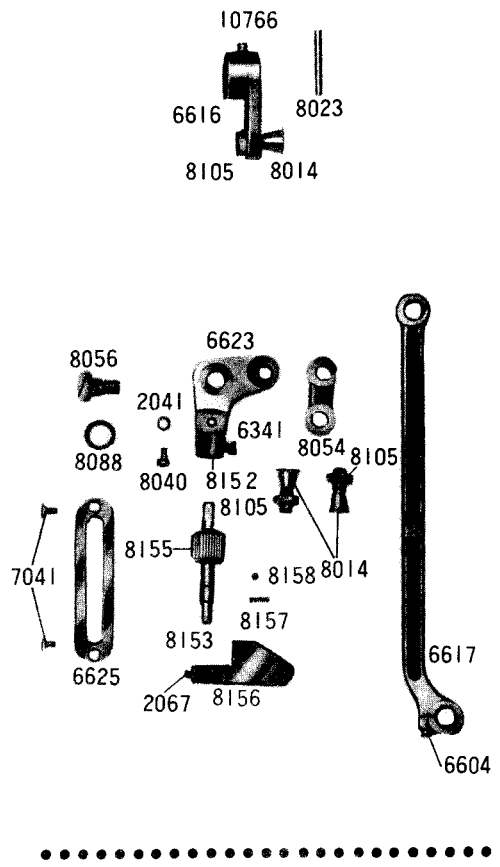

From the library of: Diamond Needle Corp

Intentionally left blank

Consolidated Sewing Machine Corp.

MAIN OFFICE

131 West 25th Street
New York, NY 10001
Tel: (212) 741-7788
Fax: (212) 741-7787

BRANCH OFFICE

7855 NW 29th Street, Bay 166
Miami, FL 33122
Tel: (305) 471-0200
Fax: (305) 471-0243